

Cree® XLamp® XP-G2 LEDs

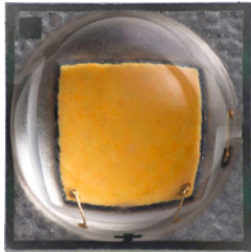

PRODUCT DESCRIPTION

The XLamp XP-G2 LED builds on the unprecedented performance of the original XP-G by increasing lumen output up to 20% while providing a single die LED point source for precise optical control. The XP-G2 LED shares the same footprint as the original XP-G, providing a seamless upgrade path and shortening the design cycle.

XLamp XP-G2 LEDs are the ideal choice for lighting applications where high light output and maximum efficacy are required, such as LED light bulbs, outdoor lighting, portable lighting, indoor lighting and solar-powered lighting.

FEATURES

- Available in white, outdoor white and 80-, 85- and 90-CRI white
- ANSI-compatible chromaticity bins
- Binned at 85 °C
- Maximum drive current: 1500 mA
- Low thermal resistance: 4 °C/W
- Wide viewing angle: 115°
- Unlimited floor life at ≤ 30 °C/85% RH
- Reflow solderable - JEDEC J-STD-020C
- Electrically neutral thermal path
- UL-recognized component (E349212)



TABLE OF CONTENTS

Flux Characteristics.....	2
Characteristics	3
Relative Spectral Power Distribution.....	3
Relative Flux vs. Junction Temperature	4
Electrical Characteristics.....	4
Thermal Design	5
Relative Flux vs. Current	6
Typical Spatial Distribution.....	6
Relative Chromaticity vs Current and Temperature	7
Reflow Soldering Characteristics ..	8
Notes.....	9
Mechanical Dimensions.....	10
Tape and Reel	11
Packaging.....	12

FLUX CHARACTERISTICS (T_j = 85 °C)

The following table provides several base order codes for XLamp XP-G2 LEDs. It is important to note that the base order codes listed here are a subset of the total available order codes for the product family.

Color	CCT Range		Base Order Codes Min. Luminous Flux @ 350 mA			Calculated Minimum Luminous Flux (lm)** @ 85 °C			Order Code
	Min.	Max.	Group	Flux (lm) @ 85 °C	Flux (lm) @ 25 °C*	700 mA	1.0 A	1.5 A	
Cool White	5000 K	8300 K	R3	122	138	223	297	402	XPGBWT-L1-0000-00F51
			R4	130	147	237	316	429	XPGBWT-L1-0000-00G51
			R5	139	158	254	338	458	XPGBWT-L1-0000-00H51
Outdoor White	3200 K	5300 K	R2	114	129	208	277	376	XPGBWT-01-0000-00EC2
			R3	122	138	223	297	402	XPGBWT-01-0000-00FC2
			R4	130	147	237	316	429	XPGBWT-01-0000-00GC2
Neutral White	3700 K	5300 K	Q5	107	121	195	260	353	XPGBWT-L1-0000-00DE4
			R2	114	129	208	277	376	XPGBWT-L1-0000-00EE4
			R3	122	138	223	297	402	XPGBWT-L1-0000-00FE4
80-CRI White	2600 K	4300 K	Q4	100	113	182	243	330	XPGBWT-H1-0000-00CE7
			Q5	107	121	195	260	353	XPGBWT-H1-0000-00DE7
			R2	114	129	208	277	376	XPGBWT-H1-0000-00EE7
Warm White	2600 K	3700 K	Q4	100	113	182	243	330	XPGBWT-L1-0000-00CE7
			Q5	107	121	195	260	353	XPGBWT-L1-0000-00DE7
			R2	114	129	208	277	376	XPGBWT-L1-0000-00EE7
			R3	122	138	223	297	402	XPGBWT-L1-0000-00FE7
85-CRI White	2600 K	3200 K	P3	73.9	83.8	135	180	244	XPGBWT-P1-0000-008E7
			P4	80.6	91.4	147	196	266	XPGBWT-P1-0000-009E7
			Q2	87.4	99.1	160	213	288	XPGBWT-P1-0000-00AE7
			Q3	93.9	106	172	228	310	XPGBWT-P1-0000-00BE7
90-CRI White	2600 K	3200 K	P3	73.9	83.8	135	180	244	XPGBWT-U1-0000-008E7
			P4	80.6	91.4	147	196	266	XPGBWT-U1-0000-009E7
			Q2	87.4	99.1	160	213	288	XPGBWT-U1-0000-00AE7

Notes:

- Cree maintains a tolerance of $\pm 7\%$ on flux and power measurements, ± 0.005 on chromaticity (CCx, CCy) measurements and ± 2 on CRI measurements.
- Typical CRI for Cool White (5000 K - 8300 K CCT) is 70.
- Typical CRI for Neutral White (3700 K - 5300 K CCT) is 75.
- Typical CRI for Outdoor White (4000 K - 5300 K CCT) is 70.
- Typical CRI for Warm White (2600 K - 3700 K CCT) is 80.
- Minimum CRI for 80-CRI White is 80.
- Minimum CRI for 85-CRI White is 85.
- Minimum CRI for 90-CRI White is 90.
- * Flux values @ 25 °C are calculated and for reference only.
- ** Calculated flux values at 700 mA, 1 A and 1.5 A are for reference only.

CHARACTERISTICS

Characteristics	Unit	Minimum	Typical	Maximum
Thermal resistance, junction to solder point	°C/W		4	
Viewing angle (FWHM)	degrees		115	
Temperature coefficient of voltage	mV/°C		-1.8	
ESD classification (HBM per Mil-Std-883D)			Class 2	
DC forward current	mA			1500
Reverse voltage	V			5
Forward voltage (@ 350 mA, 85 °C)	V		2.8	3.15
Forward voltage (@ 700 mA, 85 °C)	V		2.9	
Forward voltage (@ 1000 mA, 85 °C)	V		3.0	
Forward voltage (@ 1500 mA, 85 °C)	V		3.1	
LED junction temperature	°C			150

RELATIVE SPECTRAL POWER DISTRIBUTION

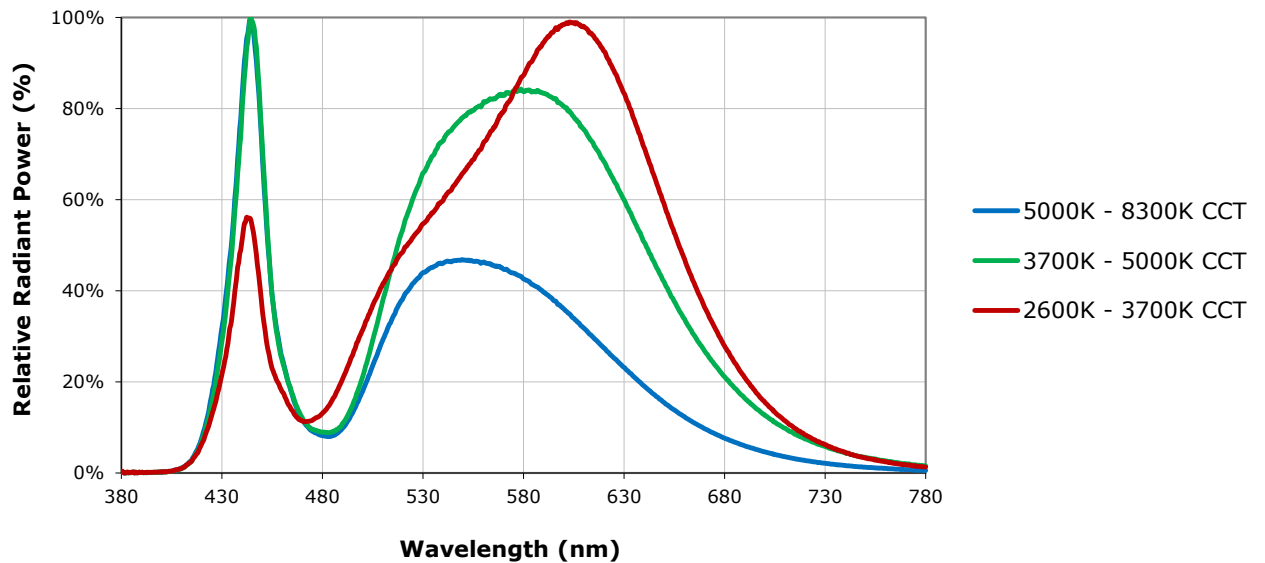

RELATIVE FLUX VS. JUNCTION TEMPERATURE ($I_F = 350 \text{ mA}$)

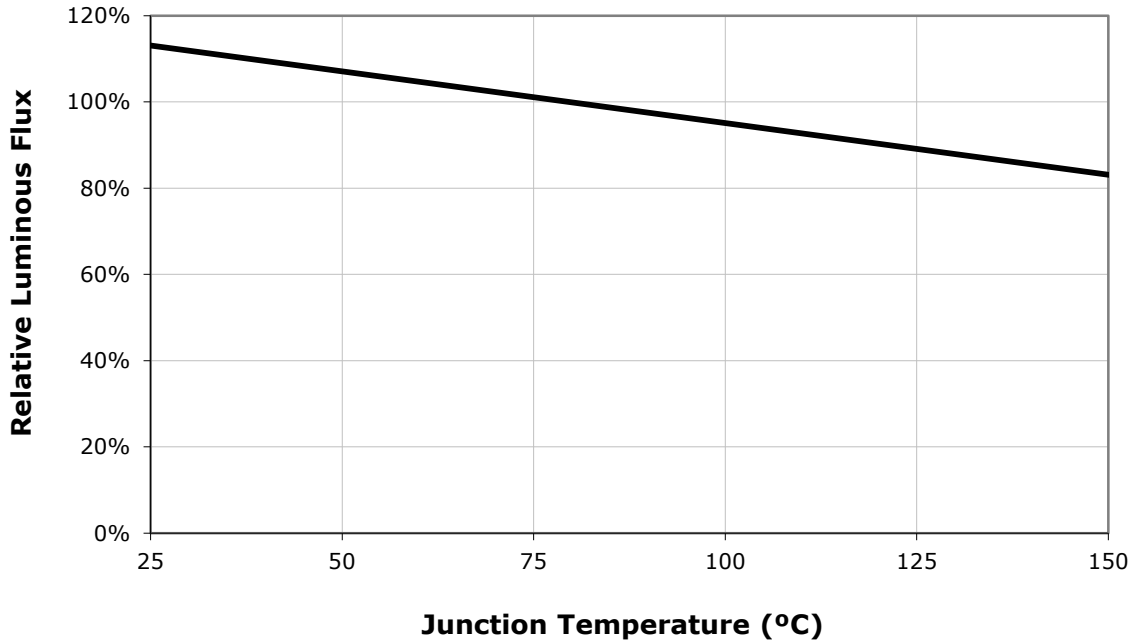

ELECTRICAL CHARACTERISTICS ($T_J = 85 \text{ °C}$)

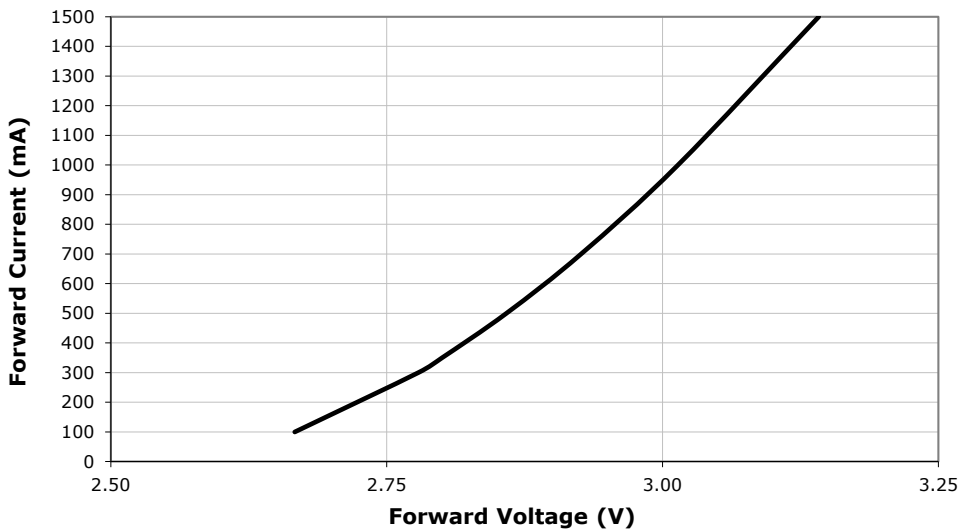

THERMAL DESIGN

The maximum forward current is determined by the thermal resistance between the LED junction and ambient. It is crucial for the end product to be designed in a manner that minimizes the thermal resistance from the solder point to ambient in order to optimize lamp life and optical characteristics.

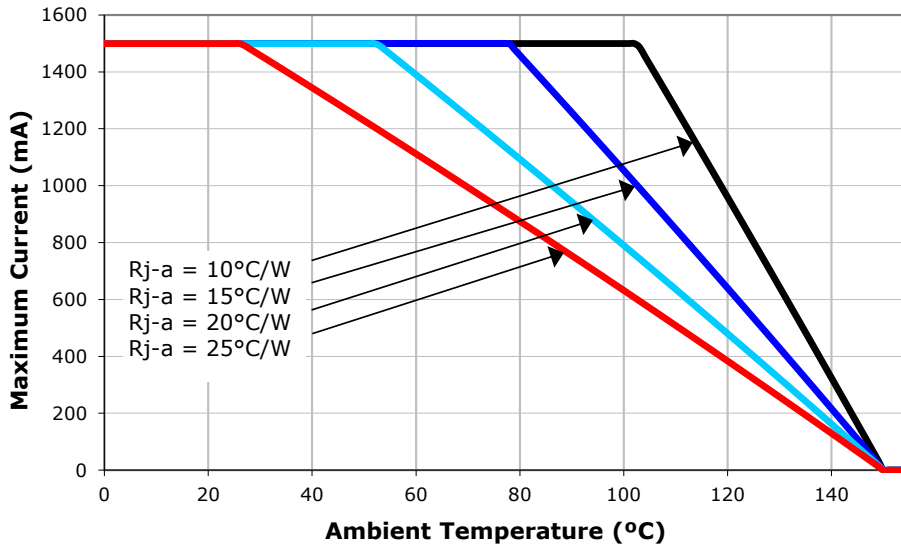

RELATIVE FLUX VS. CURRENT ($T_j = 85\text{ }^\circ\text{C}$)

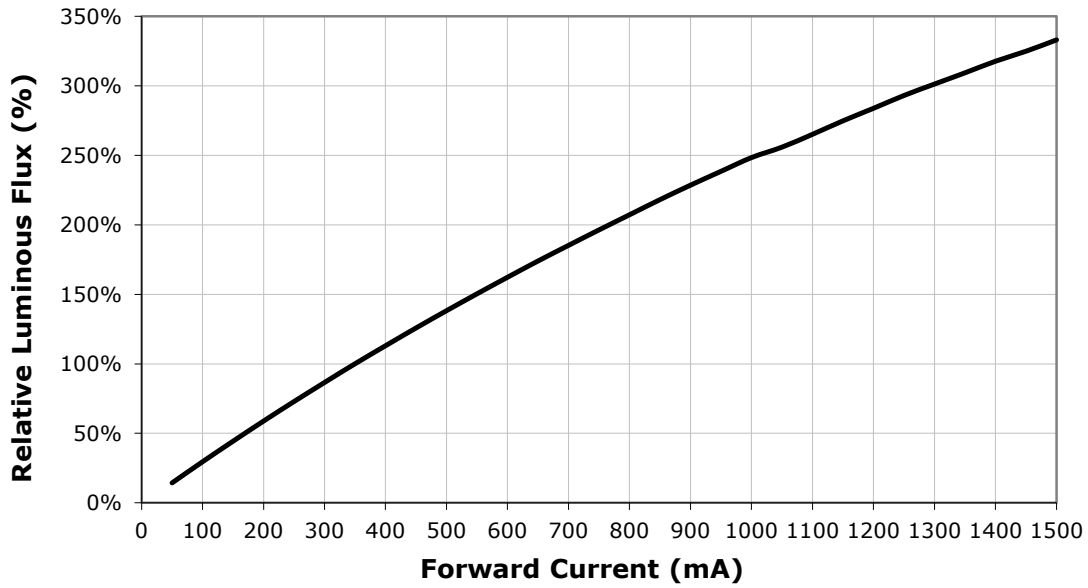

TYPICAL SPATIAL DISTRIBUTION

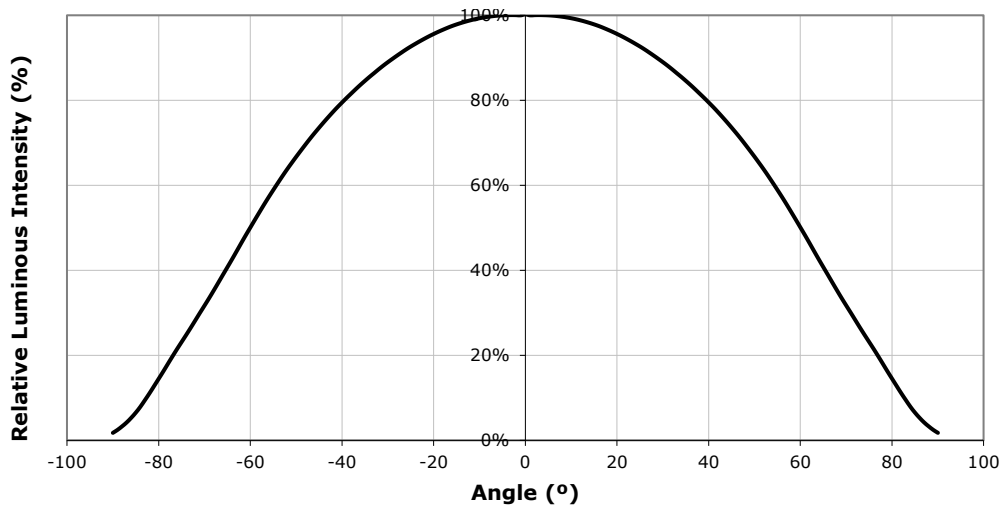

RELATIVE CHROMATICITY VS CURRENT AND TEMPERATURE (WARM WHITE*)

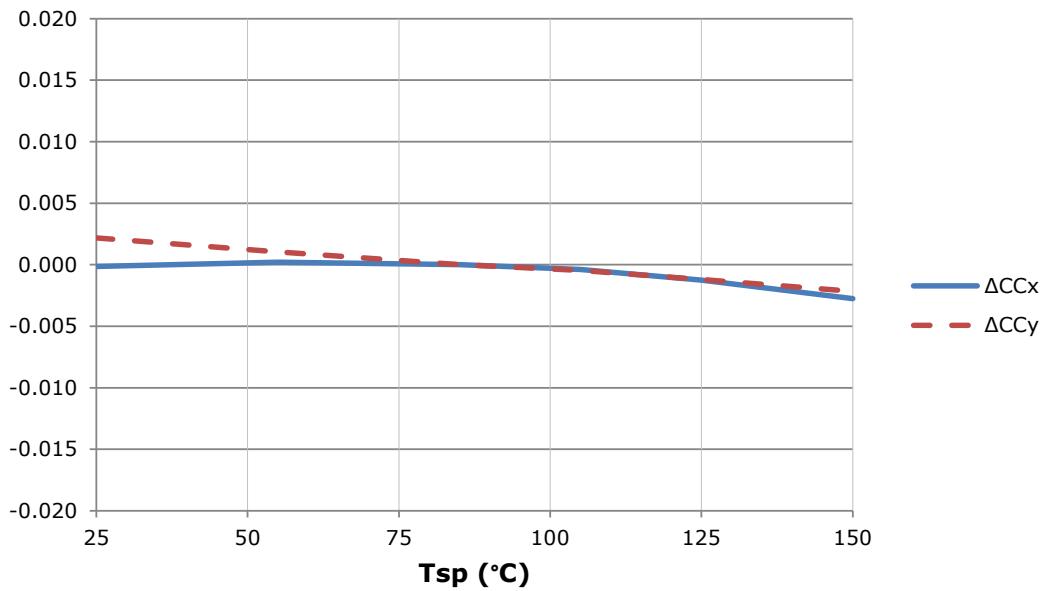
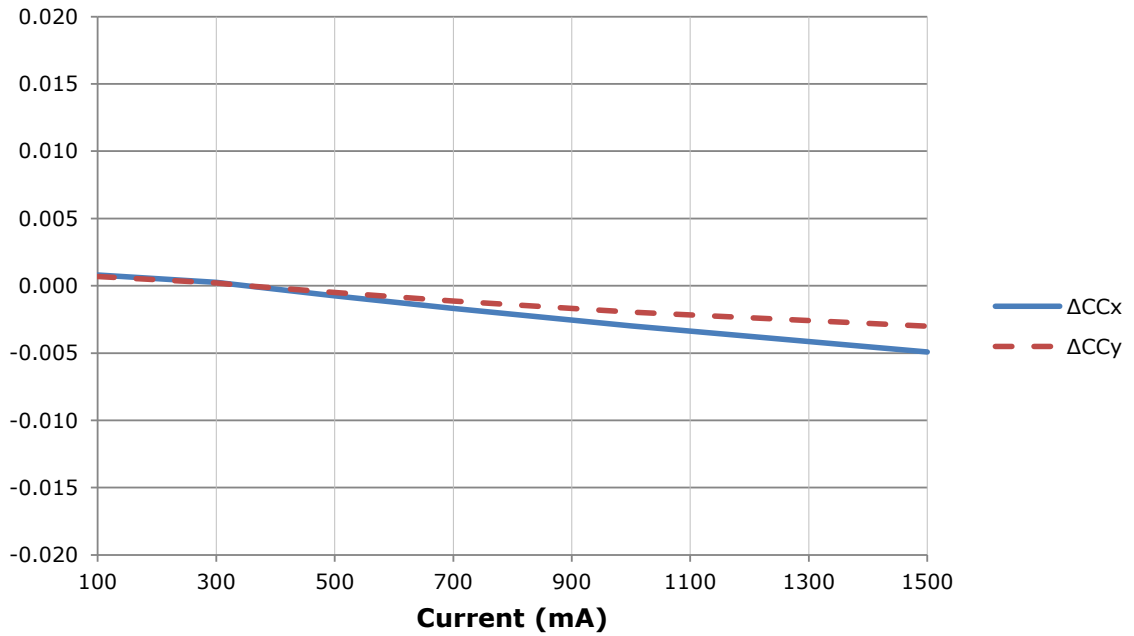

* Warm White XLamp XP-G2 LEDs have a typical CRI of 80.

REFLOW SOLDERING CHARACTERISTICS

In testing, Cree has found XLamp XP-G2 LEDs to be compatible with JEDEC J-STD-020C, using the parameters listed below. As a general guideline, Cree recommends that users follow the recommended soldering profile provided by the manufacturer of solder paste used.

Note that this general guideline may not apply to all PCB designs and configurations of reflow soldering equipment.



Profile Feature	Lead-Based Solder	Lead-Free Solder
Average Ramp-Up Rate ($T_{s_{max}}$ to T_p)	3 °C/second max.	3 °C/second max.
Preheat: Temperature Min ($T_{s_{min}}$)	100 °C	150 °C
Preheat: Temperature Max ($T_{s_{max}}$)	150 °C	200 °C
Preheat: Time ($t_{s_{min}}$ to $t_{s_{max}}$)	60-120 seconds	60-180 seconds
Time Maintained Above: Temperature (T_L)	183 °C	217 °C
Time Maintained Above: Time (t_l)	60-150 seconds	60-150 seconds
Peak/Classification Temperature (T_p)	215 °C	260 °C
Time Within 5 °C of Actual Peak Temperature (t_p)	10-30 seconds	20-40 seconds
Ramp-Down Rate	6 °C/second max.	6 °C/second max.
Time 25 °C to Peak Temperature	6 minutes max.	8 minutes max.

Note: All temperatures refer to topside of the package, measured on the package body surface.

NOTES

Lumen Maintenance Projections

Cree now uses standardized IES LM-80-08 and TM-21-11 methods for collecting long-term data and extrapolating LED lumen maintenance. For information on the specific LM-80 data sets available for this LED, refer to the public LM-80 results document at www.cree.com/xlamp_app_notes/LM80_results.

Please read the XLamp Long-Term Lumen Maintenance application note at www.cree.com/xlamp_app_notes/lumen_maintenance for more details on Cree's lumen maintenance testing and forecasting. Please read the XLamp Thermal Management application note at www.cree.com/xlamp_app_notes/thermal_management for details on how thermal design, ambient temperature, and drive current affect the LED junction temperature.

Moisture Sensitivity

In testing, Cree has found XLamp XP-G2 LEDs to have unlimited floor life in conditions ≤ 30 °C/85% relative humidity (RH). Moisture testing included a 168-hour soak at 85 °C/85% RH followed by 3 reflow cycles, with visual and electrical inspections at each stage.

Cree recommends keeping XLamp LEDs in their sealed moisture-barrier packaging until immediately prior to use. Cree also recommends returning any unused LEDs to the resealable moisture-barrier bag and closing the bag immediately after use.

UL Recognized Component

Level 4 enclosure consideration. The LED package or a portion thereof has been investigated as a fire and electrical enclosure per ANSI/UL 8750.

Vision Advisory Claim

WARNING: Do not look at exposed lamp in operation. Eye injury can result. See LED Eye Safety at www.cree.com/xlamp_app_notes/led_eye_safety.

MECHANICAL DIMENSIONS (T_A = 25 °C)

All measurements are ±.13 mm unless otherwise indicated.

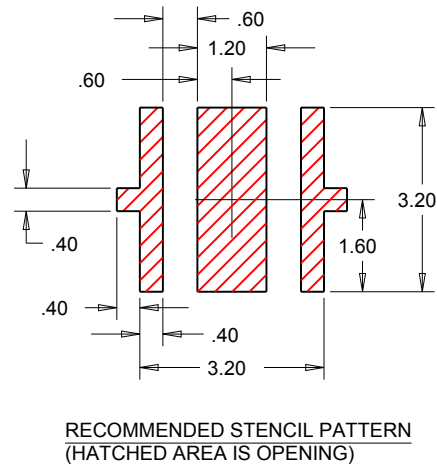
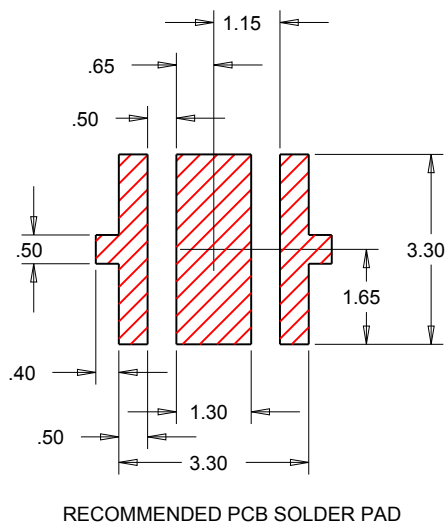
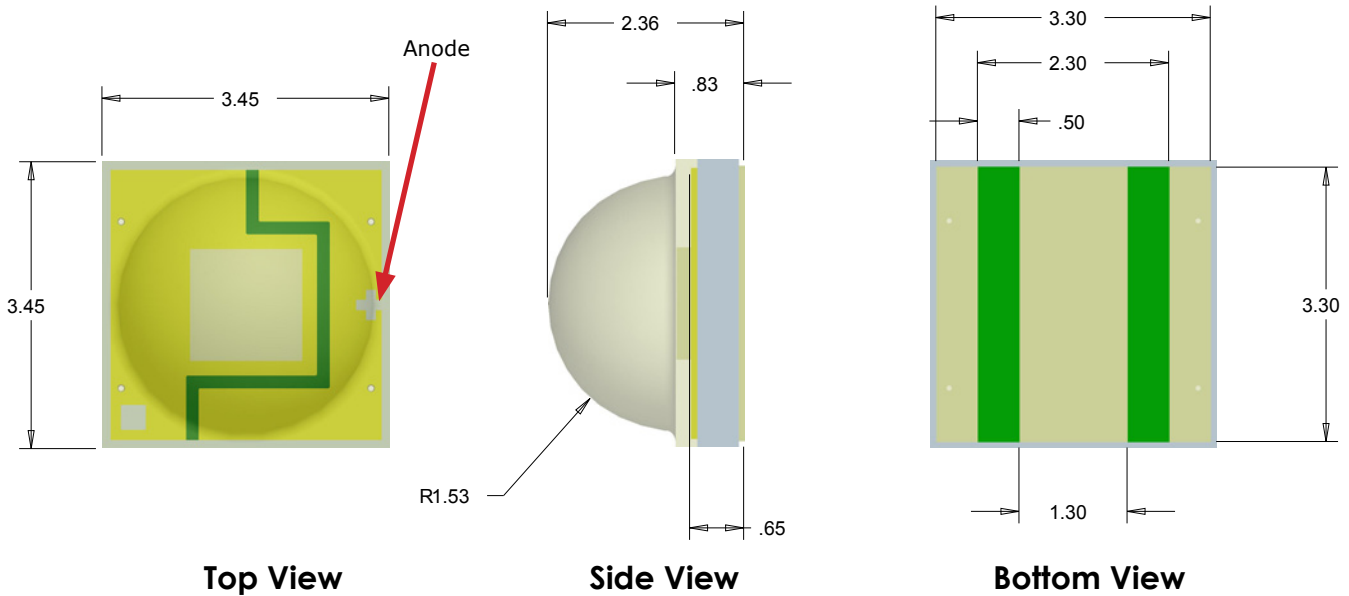
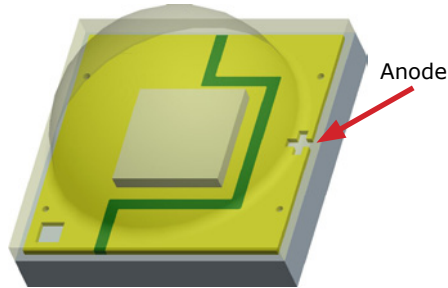

TAPE AND REEL

All Cree carrier tapes conform to EIA-481D, Automated Component Handling Systems Standard.

All dimensions in mm.

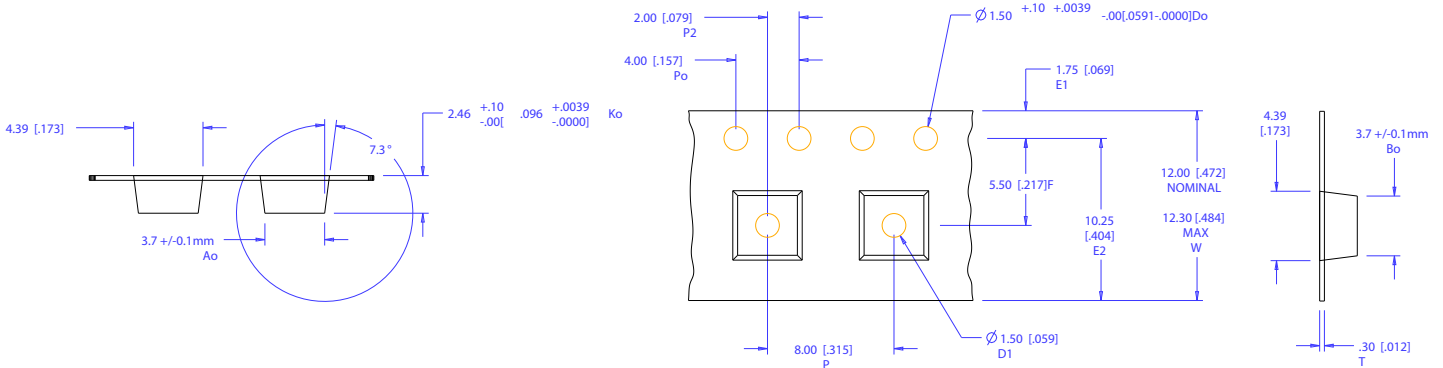

POCKET SIZE	
A_o -	3.7mm +/- 0.1mm
B_o -	3.7mm +/- 0.1mm
K_o -	2.46mm +0.1/-0mm

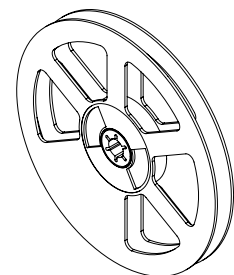
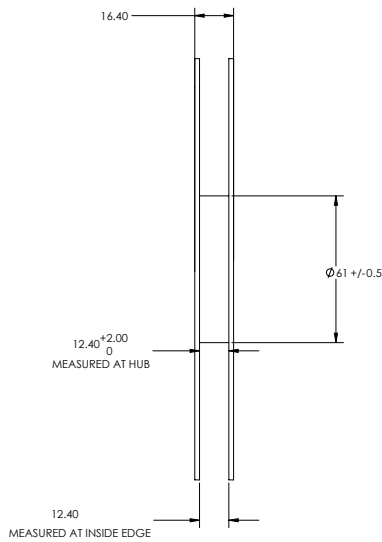
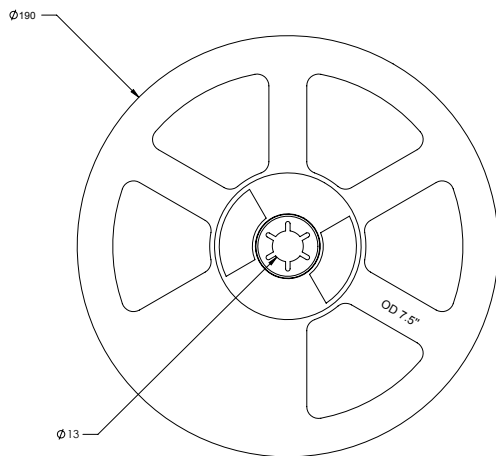
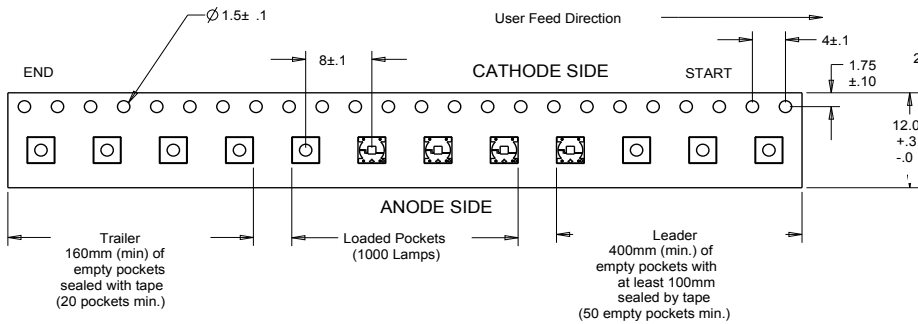

PACKAGING

Unpackaged Reel

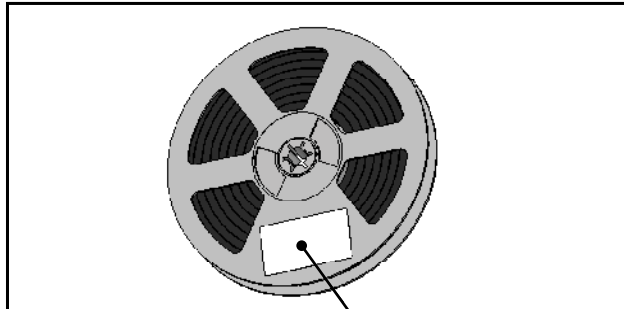

Label with Cree Bin Code, Qty, Reel ID

Packaged Reel

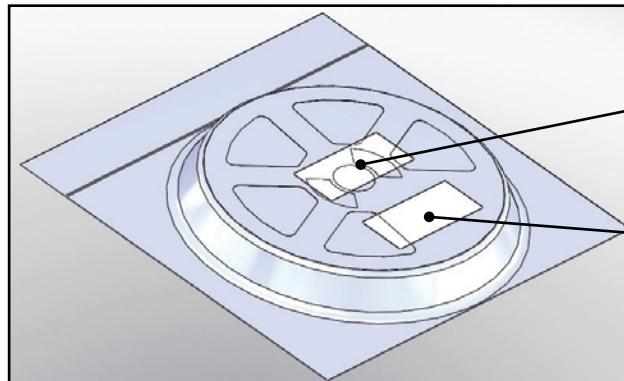

Label with Cree Order Code, Qty, Reel ID, PO #

Label with Cree Bin Code, Qty, Reel ID

Boxed Reel

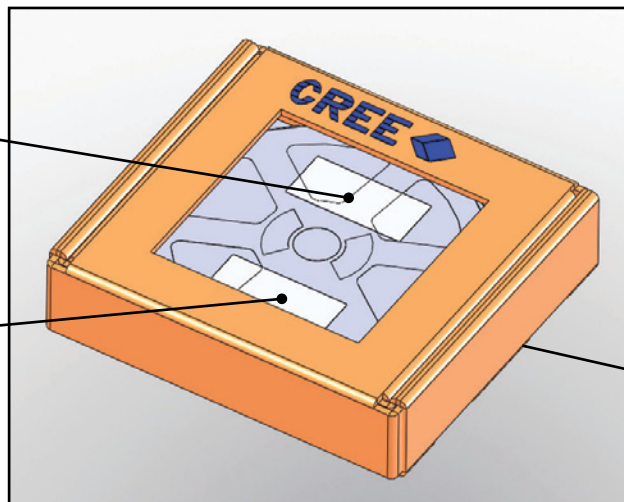

Label with Cree Order Code, Qty, Reel ID, PO #

Label with Cree Bin Code, Qty, Reel ID

Patent Label (on bottom of box)