

INTRODUCTION TO QUANTUM ALGORITHMS, POROTOCOLS AND COMPUTING

Jozef Gruska
Faculty of Informatics
Brno
Czech Republic

September 7, 2013

1. INTRODUCTION

In the first lecture we deal with main reasons **why to be interested in quantum information processing** and with very basic experiments, principles and formalism of quantum mechanics.

We deal also, in some details, with **classical reversible computations**, as **a special case of quantum computation**.

INTRODUCTORY OBSERVATIONS

In quantum computing we witness an interaction between the two most important areas of science and technology of 20-th century, between

quantum physics and informatics.

This may have important consequences for 21st century.

A VIEW of HISTORY

19th century was mainly influenced by the first industrial revolution that had its basis in the **classical mechanics** discovered, formalized and developed in the 18th century.

20th century was mainly influenced by the second industrial revolution that had its basis in **electrodynamics** discovered, formalized and developed in the 19th century.

21st century can be expected to be mainly developed by **quantum mechanics and informatics** discovered, formalized and developed in the 20th century.

FROM CLASSICAL to QUANTUM PHYSICS

At the end of 19th century it was believed by most that the laws of Newton and Maxwell were correct and complete laws of physics

At the beginning of 20th century it got clear that these laws are not sufficient to explain all observed physical phenomena.

As a result, a new mathematical framework for physics called *quantum mechanics* was formulated and new theories of physics, called *quantum physics* were developed.

QUANTUM PHYSICS

is

is an excellent theory to predict probabilities of quantum events.

Quantum physics is an elegant and conceptually simple theory that describes with astounding precision a large spectrum of the phenomena of Nature.

The predictions made on the base of quantum physics have been experimentally verified to 14 orders of precision. No conflict between predictions of theory and experiments is known.

Without quantum physics we cannot explain properties of superfluids, functioning of laser, the substance of chemistry, the structure and function of DNA, the existence and behaviour of solid bodies, color of stars, . . .

QUANTUM PHYSICS — SUBJECT

Quantum physics deals with fundamental entities of physics — particles like

- protons, electrons and neutrons (from which matter is built);
- photons (which carry electromagnetic radiation) - they are the only particles we can directly observe;
- various “elementary particles” which mediate other interactions of physics.

We call them **particles** in spite of the fact that some of their properties are totally unlike the properties of what we call particles in our ordinary world.

Indeed, it is not clear in what sense these “particles” can be said to have properties at all.

QUANTUM MECHANICS - ANOTHER VIEW

- Quantum mechanics is not physics in the usual sense - it is not about matter, or energy or waves, or particles - it is about information, probabilities, probability amplitudes and observables, and how they relate to each other.
- Quantum mechanics is what you would inevitably come up with if you would started from probability theory, and then said, let's try to generalize it so that the numbers we used to call "probabilities" can be negative numbers.

As such, the theory could be invented by mathematicians in the 19th century without any input from experiment. It was not, but it could have been (Aaronson, 1997).

**You have nothing to do but mention the quantum theory,
and people will take your voice for the voice of science, and
believe anything**

Bernard Shaw (1938)

WHAT QUANTUM PHYSICS TELL US?

Quantum physics
tells us

WHAT happens

but does not tell us

WHY it happens

and does not tell us either

HOW it happens

nor

HOW MUCH it costs

f

QUANTUM PHYSICS UNDERSTANDING

I am going to tell you what Nature behaves like.....

However do not keep saying to yourself, if you can possibly avoid it,

BUT HOW CAN IT BE LIKE THAT?

because you will get “down the drain” into a blind alley from which nobody has yet escaped.

NOBODY KNOWS HOW IT CAN BE LIKE THAT.

Richard Feynman (1965): The character of physical law.

QUANTUM MECHANICS

Quantum physics phenomena are difficult to understand since at attempts to understand quantum physics most of our everyday experiences are not applicable.

Quantum mechanics is a theory in mathematical sense: it is governed by a set of axioms.

MATHEMATICS BEHIND QUANTUM MECHANICS

- **Concerning mathematics behind quantum mechanics, one should actually do not try to understand what mathematics means, one should try to learn to work with it.**
- **Nobody saw superposition of quantum states - one can "see" only a basis state.**

QUANTUM PHYSICS

It is well known that it is very hard to understand quantum physics

however,

it is less known that understanding of quantum physics is child's play comparing with understanding of child's play.

WHY is QIPC so IMPORTANT?

There are five main reasons why QIPC is increasingly considered as of (very) large importance:

- QIPC is believed to lead to new Quantum Information Processing Technology that could have deep and broad impacts.
- Several areas of science and technology are approaching the point at which they badly need expertise with isolation, manipulating and transmission of particles.
- It is increasingly believed that new, quantum information processing based, understanding of (complex) quantum phenomena and systems can be developed.
- Quantum cryptography seems to offer new level of security and be soon feasible.
- QIPC has been shown to be more efficient in interesting/important cases.
- TCS and Information theory got new dimension and impulses.

WHY von NEUMANN

DID (COULD) NOT DISCOVER QUANTUM COMPUTING?

- **No computational complexity theory was known (and needed).**
- **Information theory was not yet well developed.**
- **Progress in physics and technology was far from what would be needed to make even rudimentary implementations.**
- **The concept of randomized algorithms was not known.**
- **No public key cryptography was known (and needed).**

DEVELOPMENT of BASIC VIEWS

on the role of information in physics:

- Information is information, nor matter, nor energy.

Norbert Wiener

- Information is physical

Ralf Landauer

Should therefore information theory and foundations of computing (complexity theory and computability theory) be a part of physics?

- Physics is informational

Should (Hilbert space) quantum mechanics be a part of Informatics?

WHEELER'S VIEW

I think of my lifetime in physics as divided into three periods

- In the first period ...I was convinced that
EVERYTHING IS PARTICLE
- I call my second period
EVERYTHING IS FIELDS
- Now I have new vision, namely that
EVERYTHING IS INFORMATION

WHEELER's "IT from BIT"

IT FROM BIT symbolizes the idea that every item of the physical world has at the bottom - at the very bottom, in most instances - an immaterial source and explanation.

Namely, that which we call **reality** arises from posing of yes-no questions, and registering of equipment-invoked responses.

In short, that things physical are information theoretic in origin.

MAIN PARADOX

- Quantum physics is extremely elaborated theory, full of paradoxes and mysteries. It takes any physicist years to develop a **feeling** for quantum mechanics.
- Some (theoretical) computer scientists/mathematicians, with almost no background in quantum physics, have been able to make **crucial contributions** to theory of quantum information processing.

PERFORMANCE OF PROCESSORS

1. There are no reasons why the increase of performance of processors should not follow **Moore law** in the near future.
2. A long term increase of performance of processors according to **Moore law** seems to be possible only if, at the performance of computational processes, we get more and more on atomic level.

EXAMPLE

An extrapolation of the curve depicting the number of electrons needed to store a bit of information shows that around 2020 we should need one electron to store one bit.

MOORE LAW

It is nowadays accepted that information processing technology has been developed for the last 50 years according to the so-called Moore law. This law has now three forms.

Economic form: Computer power doubles, for constant cost, every two years or so.

Physical form: The number of atoms needed to represent one bit of information should halve every two years or so.

Quantum form: For certain applications, quantum computers need to increase in size only by one qubit every two years or so, in order to keep pace with the classical computers performance increase.

ULTIMATE LIMITS

On the base of quantum mechanics one can determine that “ultimate laptop” of mass 1 kg and size 1 l cannot perform more than 2.7×10^{50} bit operations per second.

Calculations (Lloyd, 1999), are based only on the amount of energy needed to switch from one state to another distinguishable state.

It seems to be harder to determine the number of bits of such an “ultimate laptop”. However, the bound 3.8×10^{16} has been determined for a computer compressed to form a black hole.

It is quite clear that Moore law cannot hold longer than for another 200 years.

PRE-HISTORY

1970 Landauer demonstrated importance of reversibility for minimal energy computation;

1973 Bennett showed the existence of universal reversible Turing machines;

1981 Toffoli-Fredkin designed a universal reversible gate for Boolean logic;

1982 Benioff showed that quantum processes are at least as powerful as Turing machines;

1982 Feynman demonstrated that quantum physics cannot be simulated effectively on classical computers;

1984 Quantum cryptographic protocol BB84 was published, by Bennett and Brassard, for absolutely secure generation of shared secret random classical keys.

1985 Deutsch showed the existence of a universal quantum Turing machine.

1989 First cryptographic experiment for transmission of photons, for distance 32.5cm was performed by Bennett, Brassard and Smolin.

1993 Bernstein-Vazirani-Yao showed the existence of an efficient universal quantum Turing machine;

1993 Quantum teleportation was discovered, by Bennett et al.

1994 Shor discovered a polynomial time quantum algorithm for factorization; Cryptographic experiments were performed for the distance of 10km (using fibers).

1994 Quantum cryptography went through an experimental stage;

1995 DiVincenzo designed a universal gate with two inputs and outputs;

1995 Cirac and Zoller demonstrated a chance to build quantum computers using existing technologies.

1995 Shor showed the existence of quantum error-correcting codes.

1996 The existence of quantum fault-tolerant computation was shown by Shor.

REVERSIBILITY

QUANTUM PROCESSES ARE REVERSIBLE

An operation is reversible if its outputs uniquely determine its inputs.

$$(a, b) \rightarrow a + b$$

a non-reversible operation

$$(a, b) \rightarrow (a + b, a - b)$$

a reversible operation

$$a \rightarrow f(a)$$

A mapping
that can but
does not
have to be
reversible

$$(a, 0) \rightarrow (a, f(a))$$

a surely
reversible
operation

REVERSIBLE GATES

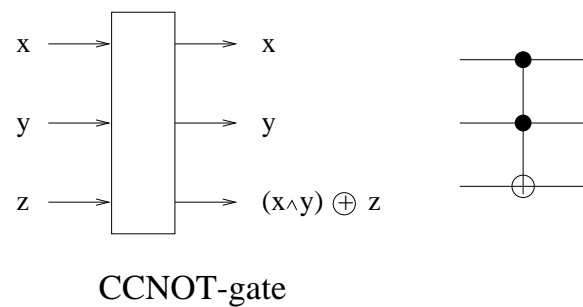
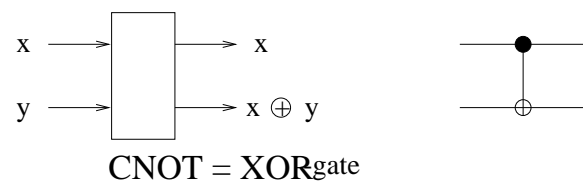
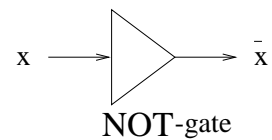

A universal reversible gate for
Boolean logic

Three reversible classical gates: NOT gate, XOR or CNOT gate and Toffoli or CCNOT gate.

UNIVERSALITY of GATES

Definition A set \mathcal{G} of gates is universal for classical computation if for any positive integers n, m and function $f : \{0, 1\}^n \rightarrow \{0, 1\}^m$, a circuit can be designed for computing f using only gates from \mathcal{G} .

Gates { NAND, FANOUT } form a universal set of gates.

The set consisting of just the Toffoli gate is also universal for classical computing (provided we add the ability to add ancillary bits to the circuit that can be initiated to either 0 or 1 as required).

GARBAGE REMOVAL

In order to produce reversible computation one needs to produce garbage (information). Its removal is possible and important.

Bennett (1973) has shown that if a function f is computable by a one-tape Turing machine in time $t(n)$, then there is a 3-tape reversible Turing machine computing, with constant time overhead, the mapping

$$a \rightarrow (a, g(a), f(a))$$

Bennett (1973) has also shown that there is an elegant reversible way how to remove garbage:

Basic computation: of $f: a \rightarrow (a, g(a), f(a))$.

Fanout: $(a, g(a), f(a)) \rightarrow (a, g(a), f(a), f(a))$

Uncomputing of f : $(a, g(a), f(a), f(a)) \rightarrow (a, f(a))$

CIRCUIT REPRESENTATION OF GARBAGE REMOVAL

Observe that CNOT gate with 0 as the initial value of the target bit is a copy gate. Indeed,

$$\text{CNOT}(x, 0) = (x, x)$$

A circuit version of the garbage removal has then the form

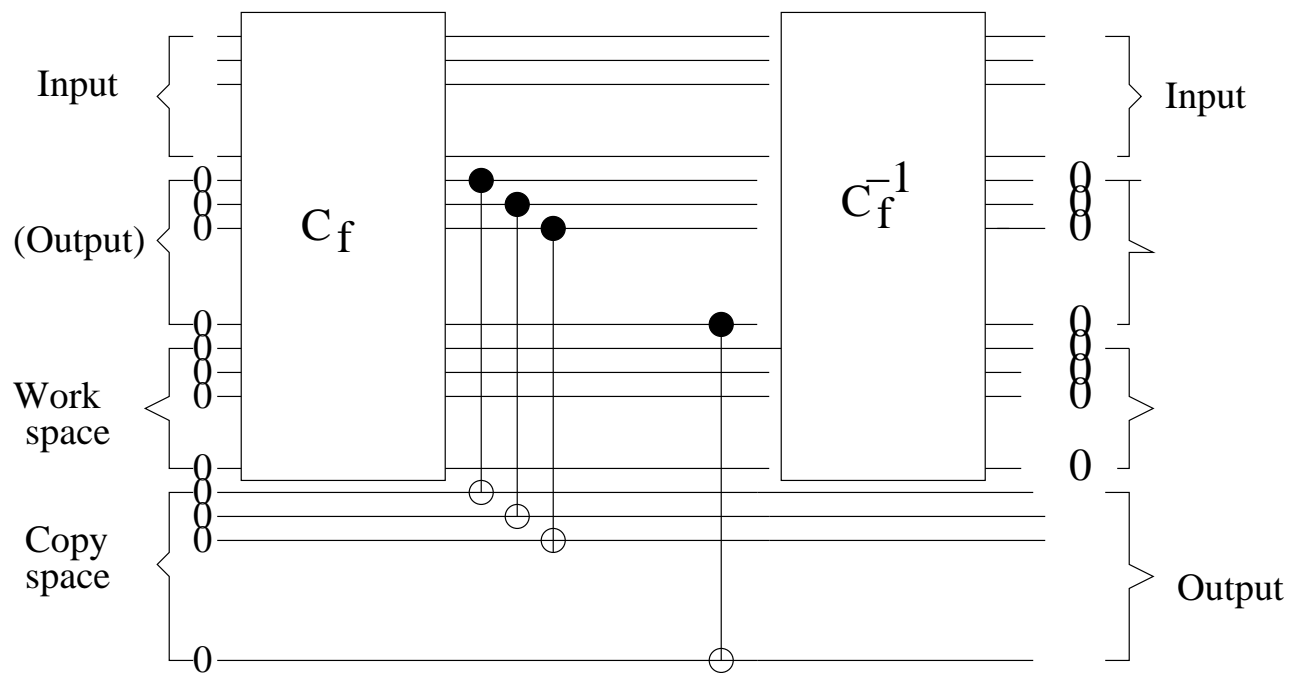

BILLIARD BALL REVERSIBLE COMPUTER

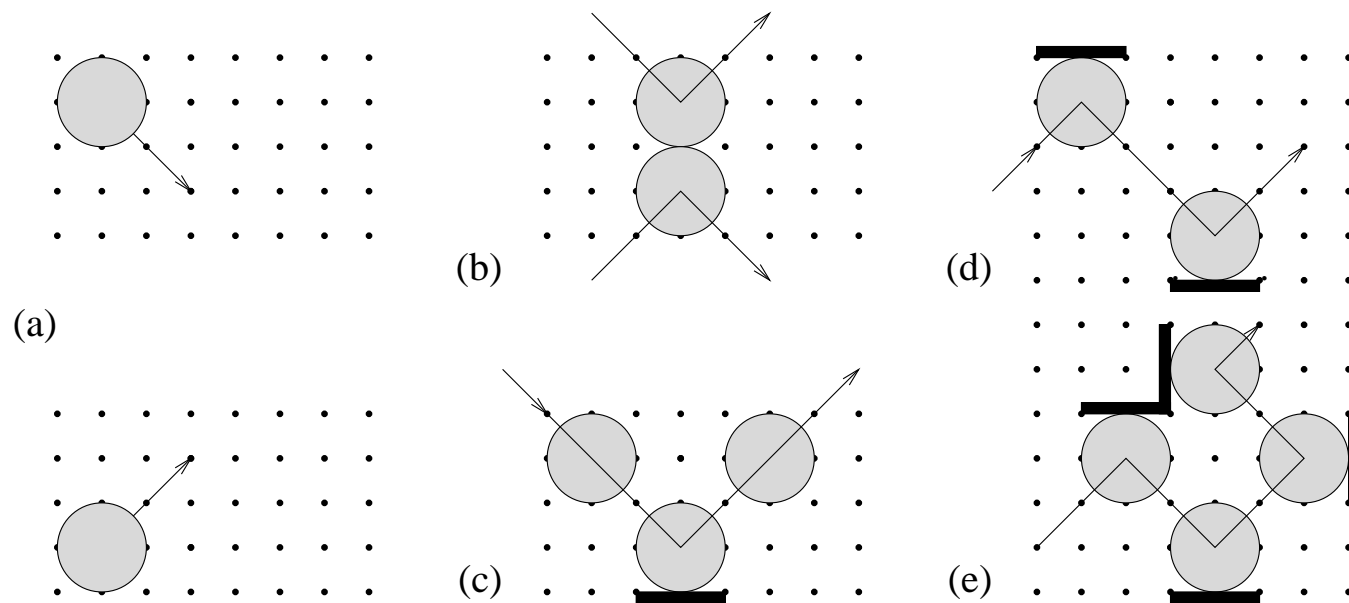

Figure 1: Billiard ball model of reversible computation

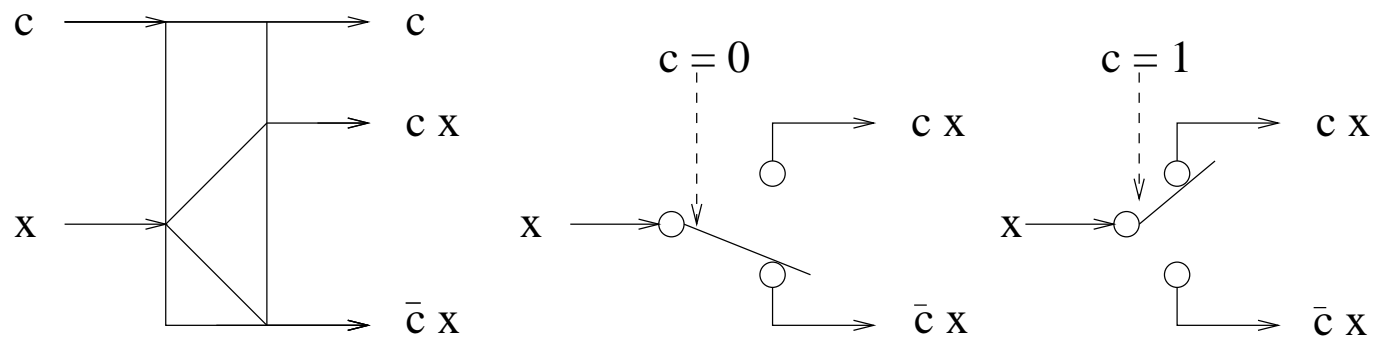

Figure 2: Switch gate

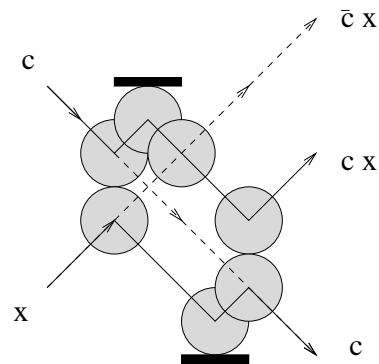

Figure 3: A billiard ball implementation of the switch gate

CLASSICAL EXPERIMENTS

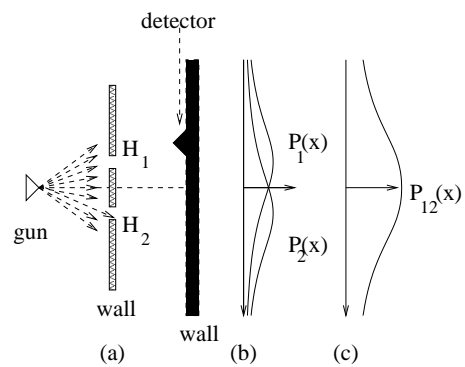

Figure 4: Experiment with bullets

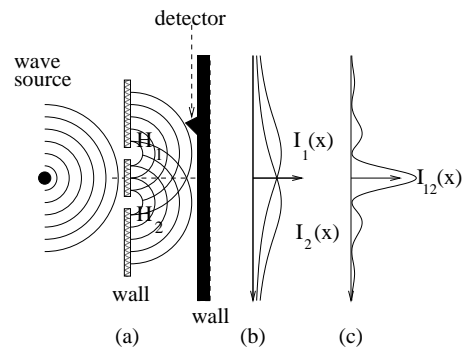

Figure 5: Experiments with waves

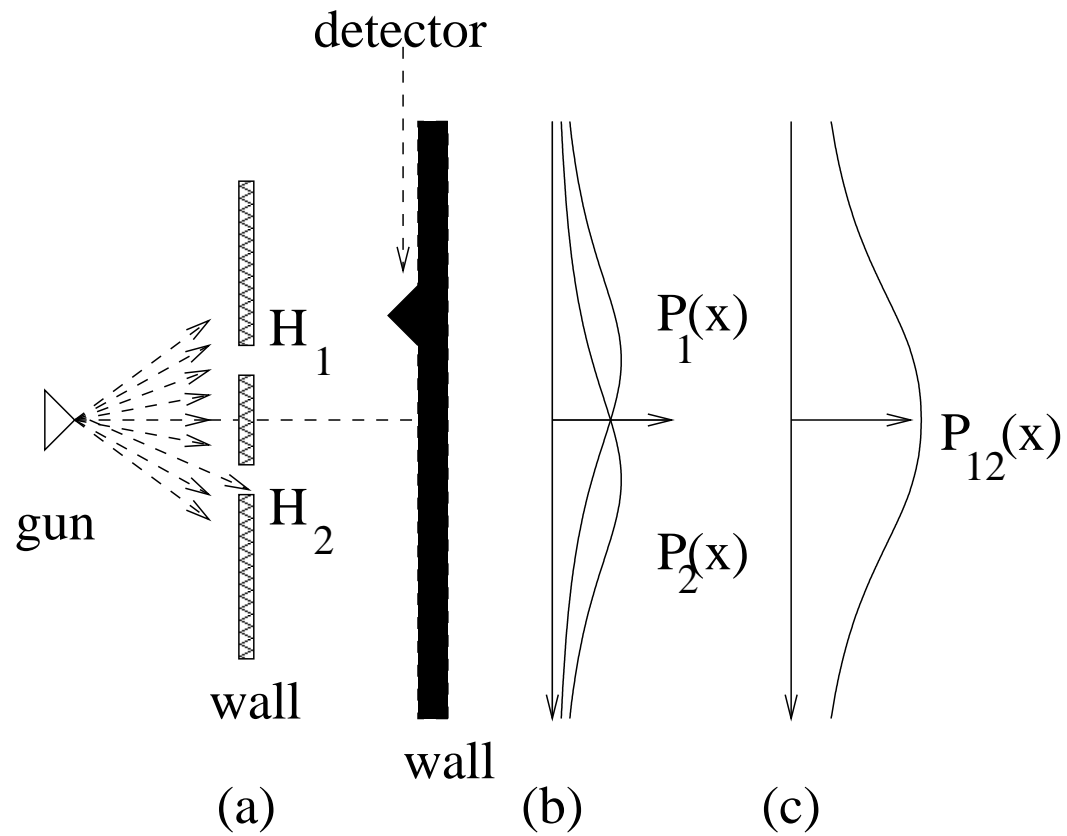

Figure 6: Experiment with bullets

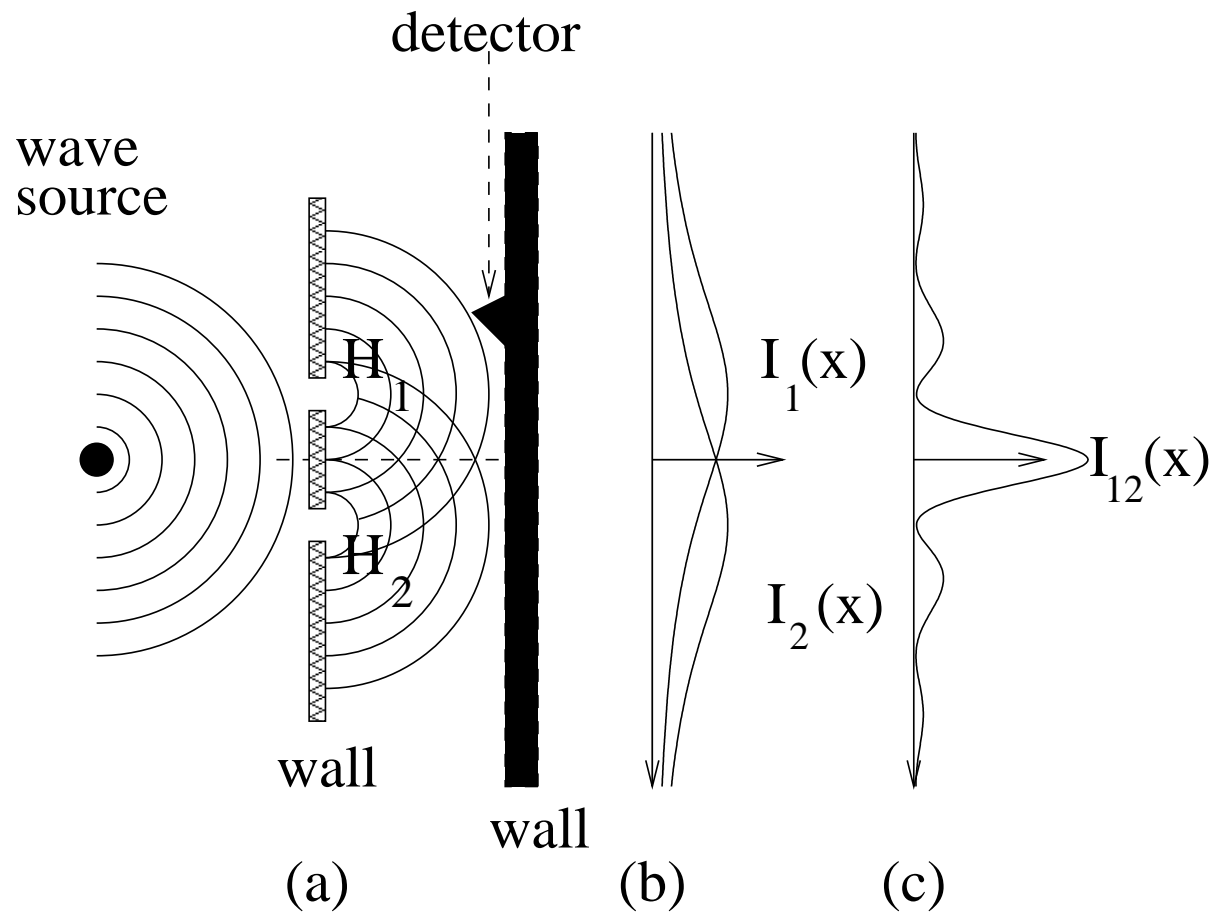

Figure 7: Experiments with waves

QUANTUM EXPERIMENTS

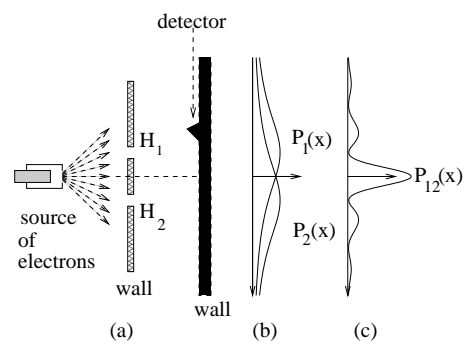

Figure 8: Two-slit experiment

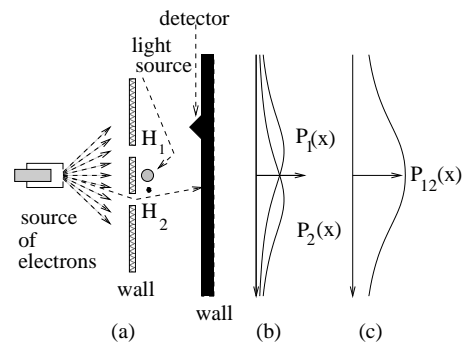

Figure 9: Two-slit experiment with an observation

QUANTUM EXPERIMENTS

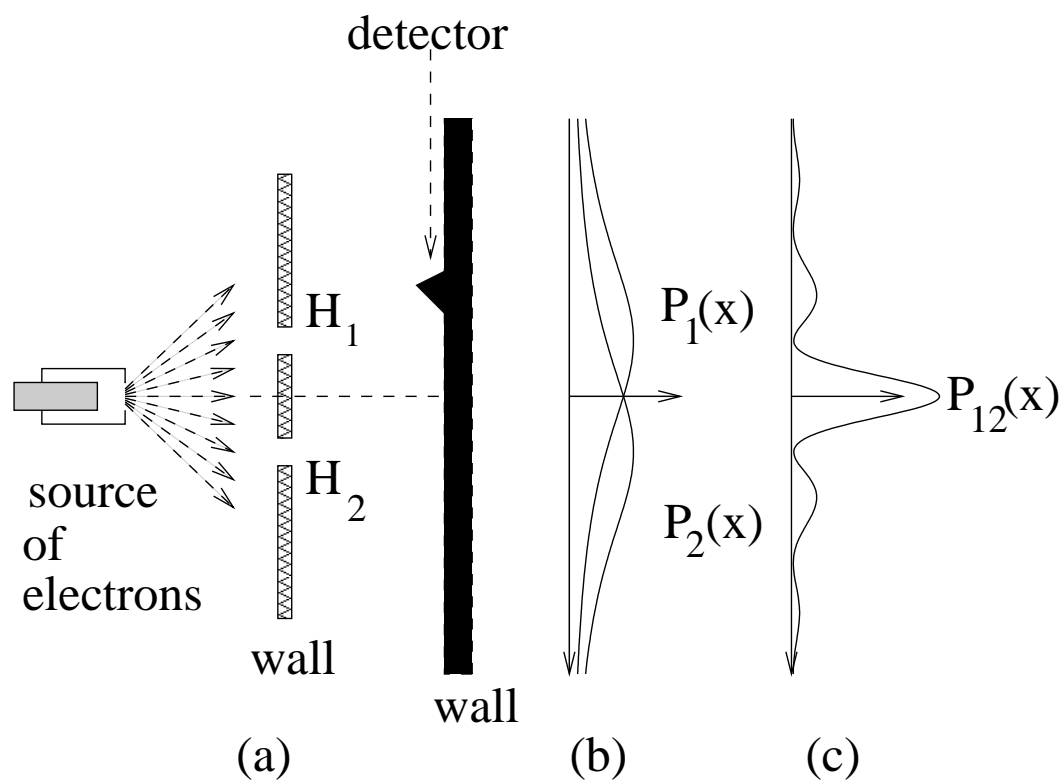

Figure 10: Two-slit experiment

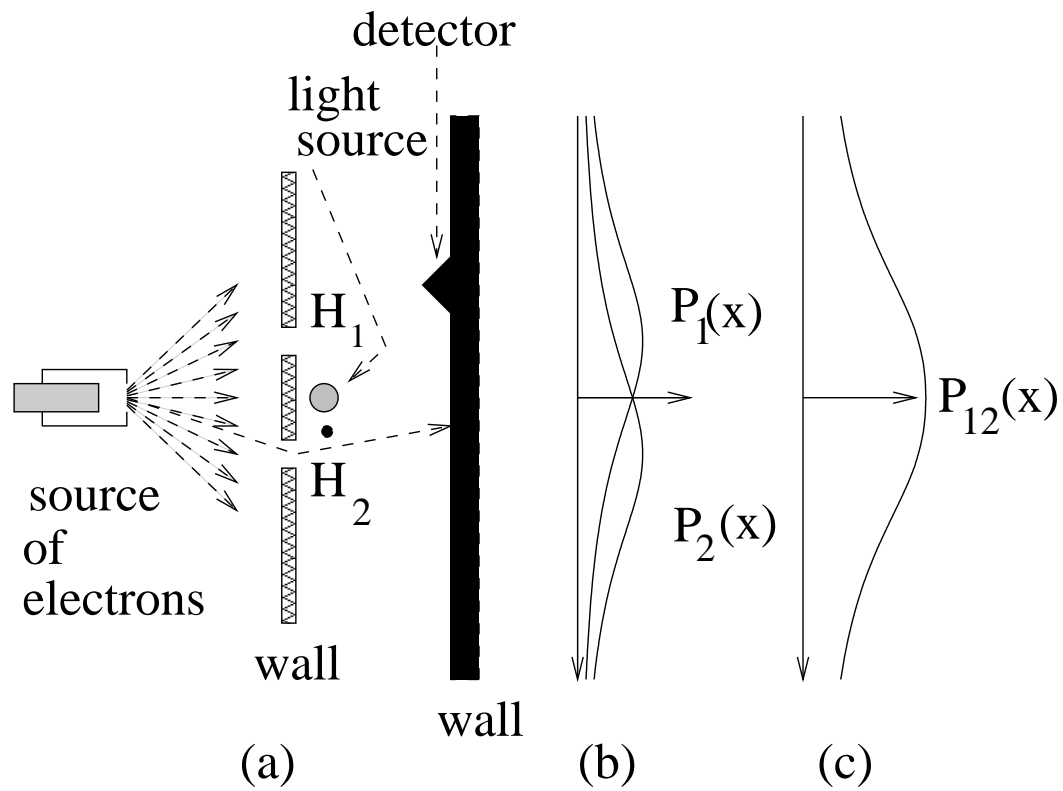

Figure 11: Two-slit experiment with an observation

TWO-SLIT EXPERIMENT – OBSERVATIONS

- Contrary to our intuition, at some places one observes fewer electrons when both slits are open, than in the case only one slit is open.
- **Electrons — particles, seem to behave as waves.**
- Each electron seems to behave as going through both holes at once.
- Results of the experiment do not depend on frequency with which electrons are shot.
- Quantum physics has no explanation where a particular electron reaches the detector wall. All quantum physics can offer are statements on the probability that an electron reaches a certain position on the detector wall.

BOHR'S WAVE-PARTICLE DUALITY PRINCIPLES

- Things we consider as waves correspond actually to particles and things we consider as particles have waves associated with them.
- The wave is associated with the position of a particle - the particle is more likely to be found in places where its wave is big.
- The distance between the peaks of the wave is related to the particle's speed; the smaller the distance, the faster particle moves.
- The wave's frequency is proportional to the particle's energy. (In fact, the particle's energy is equal exactly to its frequency times Planck's constant.)

QUANTUM MECHANICS

- **Quantum mechanics** is a theory that describes atomic and subatomic particles and their interactions.
- Quantum mechanics was born around 1925.
- A physical system consisting of one or more quantum particles is called a **quantum system**.
- To completely describe a quantum particle an **infinite-dimensional Hilbert space**.
- For quantum computational purposes it is sufficient a partial description of particle(s) given in a **finite-dimensional Hilbert (inner-product) space**.
- To each isolated quantum system we associate an inner-product vector space elements of which of norm 1 are called **(pure) states**.

THREE BASIC PRINCIPLES

P1 To each transfer from a quantum state ϕ to a state ψ a complex number

$$\langle \psi | \phi \rangle$$

is associated, which is called the **probability amplitude** of the transfer, such that

$$|\langle \psi | \phi \rangle|^2$$

is the **probability** of the transfer.

P2 If a transfer from a quantum state ϕ to a quantum state ψ can be decomposed into two subsequent transfers

$$\psi \leftarrow \phi' \leftarrow \phi$$

then the resulting amplitude of the transfer is the **product** of amplitudes of sub-transfers:

$$\langle \psi | \phi \rangle = \langle \psi | \phi' \rangle \langle \phi' | \phi \rangle$$

P3 If the transfer from ϕ to ψ has two independent alternatives, with amplitudes α and β

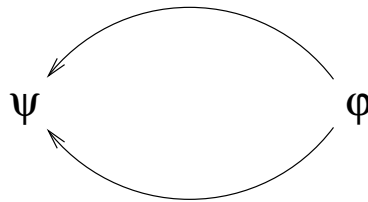

then the resulting amplitude is the sum $\alpha + \beta$ of amplitudes of two sub-transfers.

QUANTUM SYSTEM = HILBERT SPACE

Hilbert space \mathcal{H}_n is n -dimensional complex vector space with scalar product

$$\langle \psi | \phi \rangle = \sum_{i=1}^n \phi_i \psi_i^* \quad \text{of vectors } |\phi\rangle = \begin{pmatrix} \phi_1 \\ \phi_2 \\ \vdots \\ \phi_n \end{pmatrix}, |\psi\rangle = \begin{pmatrix} \psi_1 \\ \psi_2 \\ \vdots \\ \psi_n \end{pmatrix},$$

norm of vectors

$$\|\phi\| = \sqrt{|\langle \phi | \phi \rangle|}$$

and the metric

$$\text{dist}(\phi, \psi) = \|\phi - \psi\|.$$

This allows us to introduce on \mathcal{H} a topology and such concepts as continuity.
Elements (vectors) of a Hilbert space \mathcal{H} are usually called **pure states** of \mathcal{H} .

ORTHOGONALITY of PURE STATES

Two quantum states $|\phi\rangle$ and $|\psi\rangle$ are called **orthogonal if their scalar product is zero, that is if**

$$\langle\phi|\psi\rangle = 0.$$

Two pure quantum states are physically perfectly distinguishable only if they are orthogonal.

In every Hilbert space there are so-called **orthogonal bases all states of which are mutually orthogonal.**

BRA-KET NOTATION

Dirac introduced a very handy notation, so called bra-ket notation, to deal with amplitudes, quantum states and linear functionals $f : H \rightarrow \mathbb{C}$.

If $\psi, \phi \in H$, then

$\langle \psi | \phi \rangle$ — a number - a **scalar product of ψ and ϕ
(an amplitude of going from ϕ to ψ).**

$|\phi\rangle$ — **ket-vector — a column vector - an equivalent to ϕ**

$\langle \psi |$ — **bra-vector – a row vector - the conjugate transpose of $|\psi\rangle$ – a linear functional on H**

such that $\langle \psi | (|\phi\rangle) = \langle \psi | \phi \rangle$

Example If $\phi = (\phi_1, \dots, \phi_n)$ and $\psi = (\psi_1, \dots, \psi_n)$, then

ket vector - $|\phi\rangle = \begin{pmatrix} \phi_1 \\ \vdots \\ \phi_n \end{pmatrix}$ and $\langle\psi| = (\psi_1^*, \dots, \psi_n^*)$ — **bra-vector**

and

inner product - scalar product: $\langle\phi|\psi\rangle = \sum_{i=1}^n \phi_i^* \psi_i$

outer product: $|\phi\rangle\langle\psi| = \begin{pmatrix} \phi_1\psi_1^* & \dots & \phi_1\psi_n^* \\ \vdots & \ddots & \vdots \\ \phi_n\psi_1^* & \vdots & \phi_n\psi_n^* \end{pmatrix}$

The meaning of the outproduct $|\phi\rangle\langle\psi|$ is that of the mapping that maps any state $|\gamma\rangle$ into the state

$$|\phi\rangle\langle\psi|(|\gamma\rangle) = |\phi\rangle(\langle\psi|\gamma\rangle) = \langle\psi|\gamma\rangle|\phi\rangle$$

It is often said that physical counterparts of **vectors of n -dimensional Hilbert spaces** are **n -level quantum systems**.

QUBITS

A **qubit** - a two-level quantum system is a quantum state in H_2

$$|\phi\rangle = \alpha|0\rangle + \beta|1\rangle$$

where $\alpha, \beta \in \mathbb{C}$ are such that $|\alpha|^2 + |\beta|^2 = 1$ and

$\{|0\rangle, |1\rangle\}$ is a (standard) basis of H_2

EXAMPLE: Representation of qubits by

(a) electron in a Hydrogen atom — (b) a spin- $\frac{1}{2}$ particle

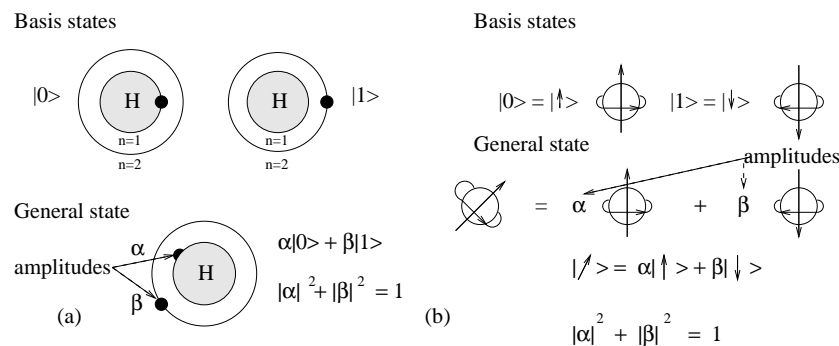

Figure 12: Qubit representations by energy levels of an electron in a hydrogen atom and by a spin- $\frac{1}{2}$ particle. The condition $|\alpha|^2 + |\beta|^2 = 1$ is a legal one if $|\alpha|^2$ and $|\beta|^2$ are to be the probabilities of being in one of two basis states (of electrons or photons).

X

CLASSICAL versus QUANTUM COMPUTING

The essence of the difference
between
classical computers and quantum computers
is in the way information is stored and processed.

In classical computers, information is represented on **macroscopic level** by **bits**, which can take one of the two values

0 or 1

In quantum computers, information is represented on **microscopic level** using **qubits**, which can take on any from uncountable many values

$$\alpha|0\rangle + \beta|1\rangle$$

where α, β are arbitrary complex numbers such that

$$|\alpha|^2 + |\beta|^2 = 1.$$

HILBERT SPACE H_2

STANDARD (COMPUTATIONAL) BASIS

$$\begin{array}{l} |0\rangle, |1\rangle \\ \begin{pmatrix} 1 \\ 0 \end{pmatrix} \quad \begin{pmatrix} 0 \\ 1 \end{pmatrix} \end{array}$$

DUAL BASIS

$$\begin{array}{l} |0'\rangle, |1'\rangle \\ \begin{pmatrix} \frac{1}{\sqrt{2}} \\ \frac{1}{\sqrt{2}} \end{pmatrix} \quad \begin{pmatrix} \frac{1}{\sqrt{2}} \\ -\frac{1}{\sqrt{2}} \end{pmatrix} \end{array}$$

Hadamard matrix (Hadamard operator in the standard basis)

$$H = \frac{1}{\sqrt{2}} \begin{pmatrix} 1 & 1 \\ 1 & -1 \end{pmatrix}$$

has properties

$$H|0\rangle = |0'\rangle$$

$$H|0'\rangle = |0\rangle$$

$$H|1\rangle = |1'\rangle$$

$$H|1'\rangle = |1\rangle$$

and transforms **standard basis** $\{|0\rangle, |1\rangle\}$ into **dual (or Hadamard) basis** $\{|0'\rangle = |+\rangle, |1'\rangle = |-\rangle\}$ and vice versa.

QUANTUM EVOLUTION/COMPUTATION

EVOLUTION

COMPUTATION

in

in

QUANTUM SYSTEM

HILBERT SPACE

is described by

Schrödinger linear equation

$$i\hbar \frac{\partial \psi(t)}{\partial t} = H(t)\psi(t),$$

where $H(t)$ is a Hermitian operator representing total energy of the system, from which it follows that $\psi(t) = e^{-\frac{i}{\hbar}H(t)}$ and therefore that an discretized evolution (computation) step of a quantum system is performed by a multiplication of the state vector by a **unitary operator**, i.e. a step of evolution is a multiplication by a **unitary matrix** A of a vector $|\psi\rangle$, i.e.

$$A|\psi\rangle$$

A matrix A is **unitary** if for A and its adjoint matrix A^\dagger (with $A_{ij}^\dagger = (A_{ji})^*$) it holds:

$$A \cdot A^\dagger = A^\dagger \cdot A = I$$

ANOTHER VIEW of UNITARITY

A unitary mapping U is a linear mapping that preserves the inner product, that is

$$\langle U\phi|U\psi\rangle = \langle\phi|\psi\rangle.$$

HAMILTONIANS

**The Schrödinger equation tells us how a quantum system evolves
subject to the Hamiltonian**

**However, in order to do quantum mechanics, one has to know
how to pick up the Hamiltonian.**

**The principles that tell us how to do so are real bridge principles
of quantum mechanics.**

**Each quantum system is actually uniquely determined by a
Hamiltonian.**

UNITARY MATRICES — EXAMPLES

In the following there are examples of unitary matrices of degree 2

Pauli matrices $\sigma_x = \begin{pmatrix} 0 & 1 \\ 1 & 0 \end{pmatrix}$ $\sigma_y = \begin{pmatrix} 0 & -i \\ i & 0 \end{pmatrix}$ $\sigma_z = \begin{pmatrix} 1 & 0 \\ 0 & -1 \end{pmatrix}$

Hadamard matrix $= \begin{pmatrix} \frac{1}{\sqrt{2}} & \frac{1}{\sqrt{2}} \\ \frac{1}{\sqrt{2}} & -\frac{1}{\sqrt{2}} \end{pmatrix}$ $\frac{1}{2} \begin{pmatrix} 1 - i & 1 + i \\ 1 + i & 1 - i \end{pmatrix} = \sqrt{\sigma_x}$ — **matrix**

$$\begin{pmatrix} i \cos \theta & \sin \theta \\ \sin \theta & i \cos \theta \end{pmatrix} \quad \begin{pmatrix} e^{i\alpha} \cos \theta & -ie^{i(\alpha-\theta)} \sin \theta \\ -ie^{i(\alpha+\theta)} \sin \theta & e^{i\alpha} \cos \theta \end{pmatrix}$$

Pauli matrices play a very important role in quantum computing.

A UNIVERSAL SET of QUANTUM GATES

The main task at quantum computation is to express solution of a given problem P as a unitary matrix U_P and then to construct a circuit C_{U_P} with elementary quantum gates from a universal set of quantum gates to realize U . That is

$$P \rightarrow U_P \rightarrow C_{U_P}.$$

A simple universal set of quantum gates consists of gates

$$\mathbf{CNOT} = \begin{pmatrix} 1 & 0 & 0 & 0 \\ 0 & 1 & 0 & 0 \\ 0 & 0 & 0 & 1 \\ 0 & 0 & 1 & 0 \end{pmatrix}, H = \frac{1}{\sqrt{2}} \begin{pmatrix} 1 & 1 \\ 1 & -1 \end{pmatrix}, \sigma_z^{1/4} = \begin{pmatrix} 1 & 0 \\ 0 & e^{\frac{\pi}{4}i} \end{pmatrix}$$

SOLVING SCHRÖDINGER EQUATION

For the Hamiltonian

$$H = \frac{\pi\hbar}{2} \begin{pmatrix} 0 & 0 & 0 & 0 \\ 0 & 0 & 0 & 0 \\ 0 & 0 & 1 & -1 \\ 0 & 0 & -1 & 1 \end{pmatrix} = \frac{\pi\hbar}{2} V$$

the Schödinger equation

$$i\hbar \frac{\partial U(t)}{\partial t} = HU(t)$$

has the solution

$$U(t) = e^{-\frac{i}{\hbar}Ht} = \sum_{k=1}^{\infty} \frac{(-\frac{i\pi}{2})^k V^k t^k}{k!} = I + \frac{1}{2} \sum_{k=0}^{\infty} \frac{(-\pi it)^k}{k!} V$$

and therefore for $t = 1$,

$$e^{-\frac{i\pi}{2}V} = I + \frac{1}{2}(e^{-i\pi} - 1)V = I - V = CNOT.$$

STERN-GERLACH MEASUREMENT EXPERIMENT

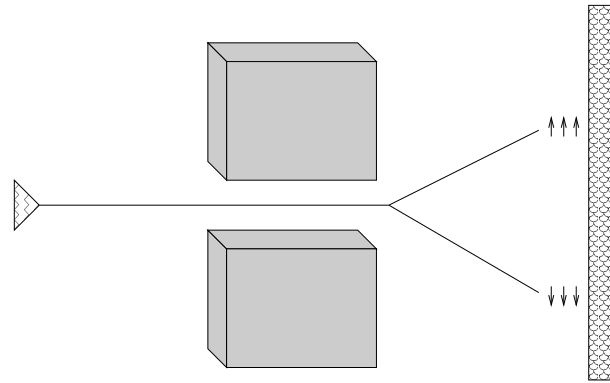

Figure 13: Stern-Gerlach experiment with spin- $\frac{1}{2}$ particles

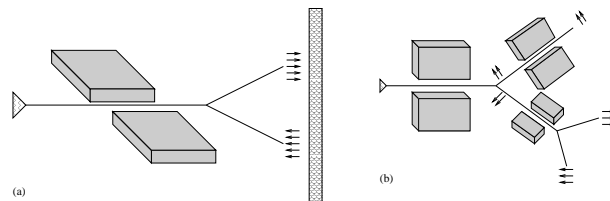

Figure 14: Several Stern-Gerlach magnets

Stern-Gerlach experiment indicated that a measurement of an n -level quantum state makes the state to collapse to one of the basis states and produces only one of n -possible classical outcomes.

TENSOR PRODUCTS

of vectors $(x_1, \dots, x_n) \otimes (y_1, \dots, y_m) = (x_1y_1, \dots, x_1y_m, x_2y_1, \dots, x_2y_m, \dots, x_ny_1, \dots, x_ny_m)$

of matrices $A \otimes B = \begin{pmatrix} a_{11}B & \dots & a_{1n}B \\ \vdots & & \vdots \\ a_{n1}B & \dots & a_{nn}B \end{pmatrix}$ where $A = \begin{pmatrix} a_{11} & \dots & a_{1n} \\ \dots & & \dots \\ a_{n1} & \dots & a_{nn} \end{pmatrix}$

Example

$$\begin{pmatrix} 1 & 0 \\ 0 & 1 \end{pmatrix} \otimes \begin{pmatrix} a_{11} & a_{12} \\ a_{21} & a_{22} \end{pmatrix} = \begin{pmatrix} a_{11} & a_{12} & 0 & 0 \\ a_{21} & a_{22} & 0 & 0 \\ 0 & 0 & a_{11} & a_{12} \\ 0 & 0 & a_{21} & a_{22} \end{pmatrix} \quad \begin{pmatrix} a_{11} & a_{12} \\ a_{21} & a_{22} \end{pmatrix} \otimes \begin{pmatrix} 1 & 0 \\ 0 & 1 \end{pmatrix} = \begin{pmatrix} a_{11} & 0 & a_{12} & 0 \\ 0 & a_{11} & 0 & a_{12} \\ a_{21} & 0 & a_{22} & 0 \\ 0 & a_{21} & 0 & a_{22} \end{pmatrix}$$

of Hilbert spaces $H_1 \otimes H_2$ is the complex vector space spanned by tensor products of vectors from H_1 and H_2 , that corresponds to the quantum system composed of the quantum systems corresponding to Hilbert spaces H_1 and H_2 .

A very important difference between classical and quantum systems

A state of a compound classical (quantum) system can be (cannot be) always composed from the states of the subsystems.

QUANTUM REGISTERS

Any ordered sequence of n quantum qubit systems creates so-called **quantum n -qubit register**.

Hilbert space corresponding to an n -qubit register is n -fold tensor product of two-dimensional Hilbert spaces

$$\mathcal{H}_{2^n} = \bigotimes_{i=1}^n \mathcal{H}_2.$$

Since vectors $|0\rangle$ and $|1\rangle$ form a basis of \mathcal{H}_2 , one of the basis of \mathcal{H}_{2^n} , so-called **computational basis**, consists of all possible n -fold tensor products where $b_i \in \{0, 1\}$ for all i .

$$|b_1\rangle \otimes |b_2\rangle \otimes \dots \otimes |b_n\rangle = |b_1 b_2 \dots b_n\rangle.$$

Example A two-qubit register has as a computational basis vectors

$$|00\rangle = \begin{pmatrix} 1 \\ 0 \\ 0 \\ 0 \end{pmatrix} \quad |01\rangle = \begin{pmatrix} 0 \\ 1 \\ 0 \\ 0 \end{pmatrix} \quad |10\rangle = \begin{pmatrix} 0 \\ 0 \\ 1 \\ 0 \end{pmatrix} \quad |11\rangle = \begin{pmatrix} 0 \\ 0 \\ 0 \\ 1 \end{pmatrix}$$

QUANTUM STATES and von NEUMAN MEASUREMENT

In case an orthonormal basis $\{\beta_i\}_{i=1}^n$ is chosen in \mathcal{H}_n , any state $|\phi\rangle \in \mathcal{H}_n$ can be expressed in the form

$$|\phi\rangle = \sum_{i=1}^n a_i |\beta_i\rangle, \quad \sum_{i=1}^n |a_i|^2 = 1,$$

where

$a_i = \langle \beta_i | \phi \rangle$ are called **probability amplitudes**

and

their squares, $|a_i|^2 = \langle \phi | \beta_i \rangle \langle \beta_i | \phi \rangle$, provide **probabilities** that if the state $|\phi\rangle$ is measured with respect to the basis $\{\beta_i\}_{i=1}^n$, then the state $|\phi\rangle$ collapses into the state $|\beta_i\rangle$ with probability $|a_i|^2$.

The classical “outcome” of a (von Neumann) measurement of the state $|\phi\rangle$ with respect to the basis $\{\beta_i\}_{i=1}^n$ is the index i of that state $|\beta_i\rangle$ into which the state $|\phi\rangle$ collapses.

PHYSICAL VIEW of QUANTUM MEASUREMENT

In case an orthonormal basis $\{\beta_i\}_{i=1}^n$ is chosen in \mathcal{H}_n , it is said that an **observable** was chosen.

In such a case, a **measurement**, or an **observation**, of a state

$$|\phi\rangle = \sum_{i=1}^n a_i |\beta_i\rangle, \quad \sum_{i=1}^n |a_i|^2 = 1,$$

with respect to a basis (observable), $\{\beta_i\}_{i=1}^n$, is seen as saying that the state $|\phi\rangle$ has **property** $|\beta_i\rangle$ with probability $|a_i|^2$.

In general, any decomposition of a Hilbert space \mathcal{H} into mutually orthogonal subspaces, with the property that any quantum state can be uniquely expressed as the sum of the states from such subspaces, represents an observable (a measuring device). There are no other observables.

WHAT ARE ACTUALLY QUANTUM STATES? - TWO VIEWS

- In so called “**relative state interpretation**” of quantum mechanics a **quantum state is** interpreted as **an objective real physical object**.
- In so called “**information view of quantum mechanics**” a **quantum state is** interpreted as **a specification of (our knowledge or beliefs) probabilities** of all experiments that can be performed with the state - the idea that quantum states describe the reality is therefore abounded.

A quantum state is a useful abstraction which frequently appears in the literature, but does not really exists in nature.

A. Peres (1993)

QUANTUM (PROJECTION) MEASUREMENTS

A quantum state is observed (measured) with respect to an **observable** — a decomposition of a given Hilbert space into orthogonal subspaces (such that each vector can be uniquely represented as a sum of vectors of these subspaces).

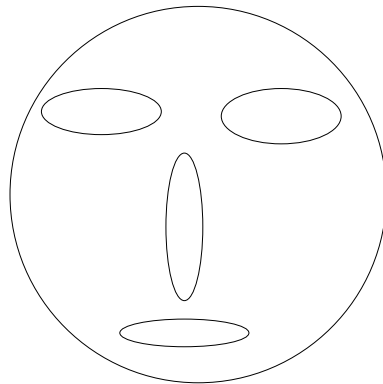

There are two outcomes of a projection measurement of a state $|\phi\rangle$:

1. Classical information into which subspace projection of $|\phi\rangle$ was made.
2. A new quantum state $|\phi'\rangle$ into which the state $|\phi\rangle$ collapses.

The subspace into which projection is made is chosen **randomly** and the corresponding probability is uniquely determined by the amplitudes at the representation of $|\phi\rangle$ at the basis states of the subspace.

CLASSICAL versus QUANTUM MECHANICS

A crucial difference between quantum theory and classical mechanics is perhaps this: whereas classical states are essentially **descriptive**, quantum states are essentially **predictive**; they encapsulate predictions concerning the values that measurements of physical quantities will yield, and these predictions are in terms of probabilities.

The state of a classical particle is given by its position $q = (q_x, q_y, q_z)$ and momentum $p = (p_x, p_y, p_z)$.

The state of n particles is therefore given by $6n$ numbers.

Hamiltonian, or total energy $H(p, q)$ of a system of n particles is then a function of $3n$ coordinates p_u^i , $i = 1, \dots, 3$, $u \in \{x, y, z\}$ and $3n$ coordinates q_u^i .

Evolution of such a system is then described by a system of $3n$ pairs of equations

$$\frac{dq_u^i}{dt} = \frac{\partial H}{\partial p_u^i} \quad \frac{dp_u^i}{dt} = -\frac{\partial H}{\partial q_u^i}$$

MEASUREMENT

in CLASSICAL versus QUANTUM physics

BEFORE QUANTUM PHYSICS

it was taken for granted that when physicists measure something, they are gaining knowledge of a pre-existing state — a knowledge of an independent fact about the world.

QUANTUM PHYSICS

says otherwise. Things are not determined except when they are measured, and it is only by being measured that they take on specific values.

A quantum measurement forces a previously indeterminate system to take on a definite value.

PROBABILISTIC versus QUANTUM SYSTEM

Let us illustrate, on an example, a principal difference between a quantum evolution and a classical probabilistic evolution.

If a qubit system develops under the evolution

$$|0\rangle \rightarrow \frac{1}{\sqrt{2}}(|0\rangle + |1\rangle) \quad |1\rangle \rightarrow \frac{1}{\sqrt{2}}(|0\rangle - |1\rangle),$$

then, after one step of evolution, we observe both $|0\rangle$ and $|1\rangle$ with the probability $\frac{1}{2}$, but after two steps we get

$$|0\rangle \leftrightarrow \frac{1}{\sqrt{2}}\left(\frac{1}{\sqrt{2}}(|0\rangle + |1\rangle) + \frac{1}{\sqrt{2}}(|0\rangle - |1\rangle)\right) = |0\rangle$$

and therefore any observation gives $|0\rangle$ with probability 1.

On the other hand, in case of the classical probabilistic evolution

$$[0] \rightarrow \frac{1}{2}[0] + \frac{1}{2}[1] \quad [1] \rightarrow \frac{1}{2}[0] + \frac{1}{2}[1]$$

we have after one step of evolution both 0 and 1 with the same probability $\frac{1}{2}$, but after two steps we have again

$$[0] \rightarrow \frac{1}{2}\left(\frac{1}{2}[0] + \frac{1}{2}[1]\right) + \frac{1}{2}\left(\frac{1}{2}[0] + \frac{1}{2}[1]\right) = \frac{1}{2}[0] + \frac{1}{2}[1]$$

and therefore, after two steps of evolution, we have again both values 0 and 1 with the same probability $\frac{1}{2}$.

In the quantum case, in the second evolution step, amplitudes at $|1\rangle$ cancel each other and we have so-called **destructive interference. At the same time, amplitudes at $|0\rangle$ amplify each other and we have so-called **constructive interference**.**

APPENDIX

VIEWS of CARVER MEAD

- **The electron is the thing that is wiggling. and the wave is electron.**
- **The electron is not something that has a fixed physical shape. As a wave, it propagates outwards - it be large or small - it expands to fit the container it is in.**
- **An electron can be a mile long - the electrons on my superconducting magnet are so long.**
- **The quantum world is the world of waves, not particles.**